



GLEN EYRIE MEETING ROOMS

# Capacity Information



# Castle

## Great Hall

2,152 Sq. Ft.

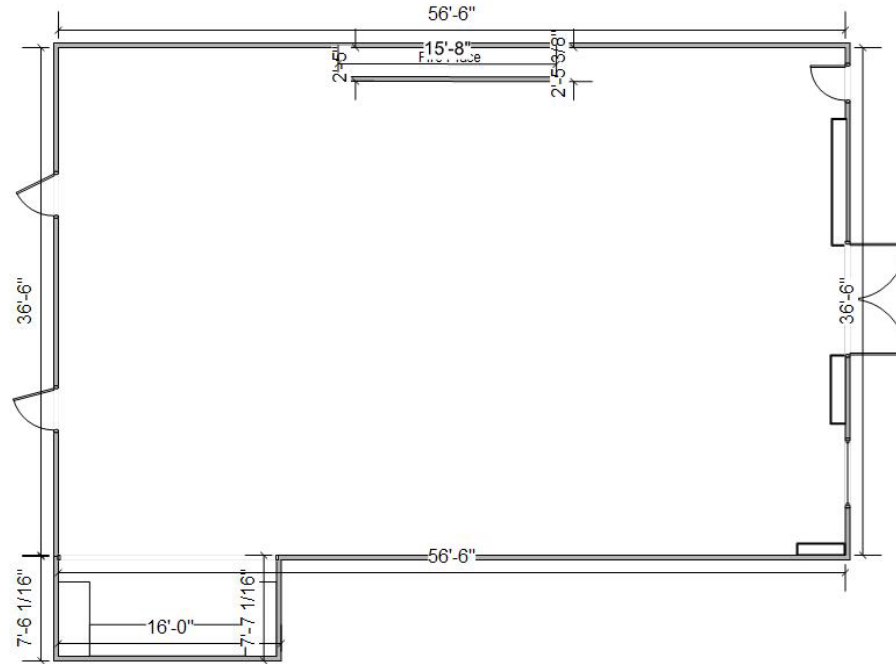

Auditorium	Classroom	Boardroom	Hollow Square Boardroom	U-Shape Boardroom	Double U-Shape Boardroom	Half Rounds	Rounds	Informal
200	100	40	64	44	72	96	128	80







# Castle

## Queen's Parlor Room

475 Sq. Ft.

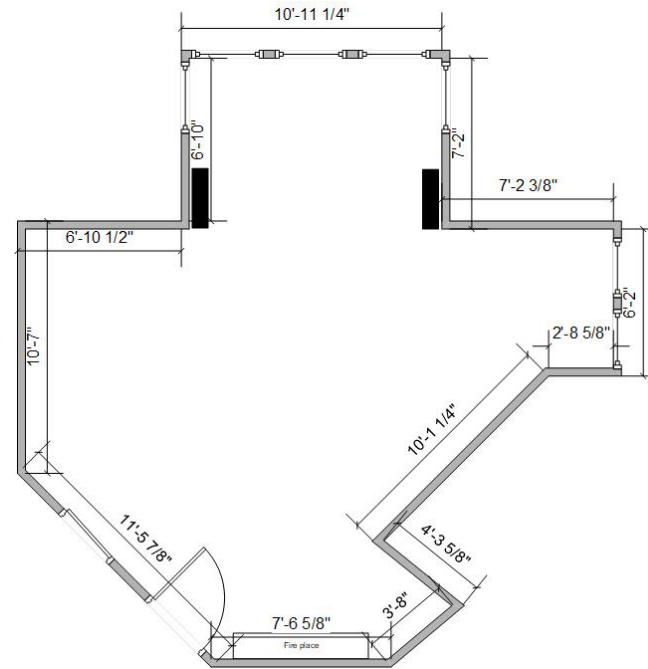
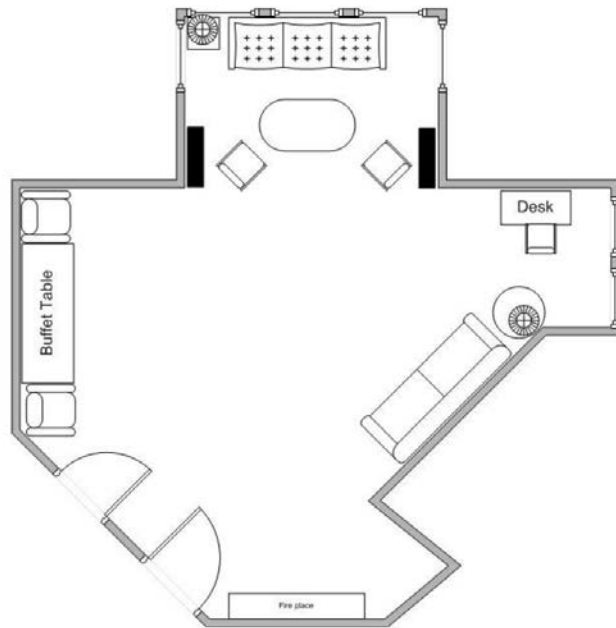

Auditorium	Classroom	Boardroom	Hollow Square Boardroom	U-Shape Boardroom	Double U-Shape Boardroom	Half Rounds	Rounds	Informal
24	8	8	-	-	-	12	16	20

# Castle

Tower Room

444 Sq. Ft.

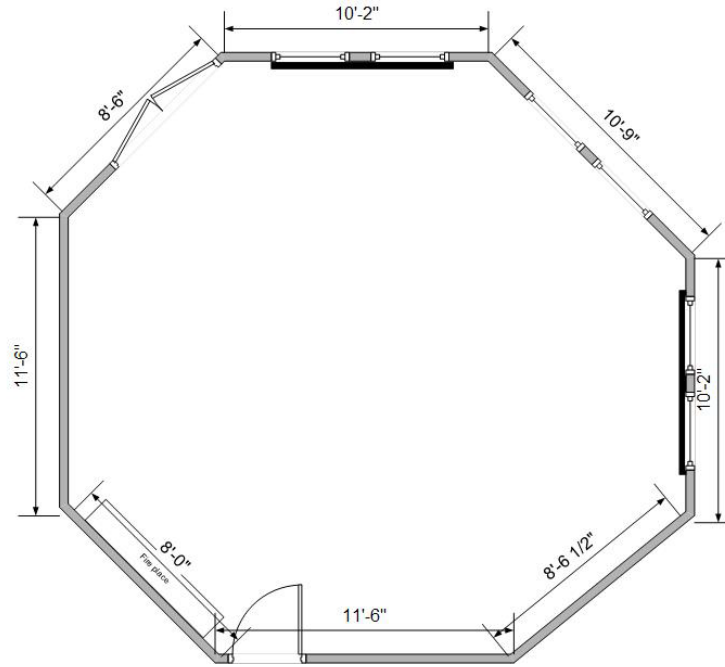

Auditorium	Classroom	Boardroom	Hollow Square Boardroom	U-Shape Boardroom	Double U-Shape Boardroom	Half Rounds	Rounds	Informal
40	20	16	20	12	-	25	29	36



# Carriage House

Carriage Room

1,159 Sq. Ft.

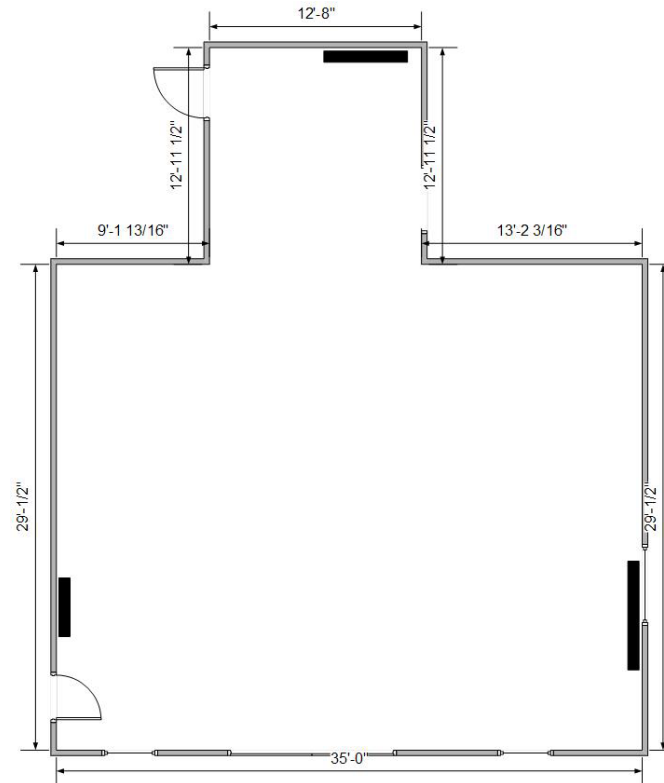

Auditorium	Classroom	Boardroom	Hollow Square Boardroom	U-Shape Boardroom	Double U-Shape Boardroom	Half Rounds	Rounds	Informal
100	48	24	32	28	38	54	72	45

# Carriage House

Granary

350 Sq. Ft.

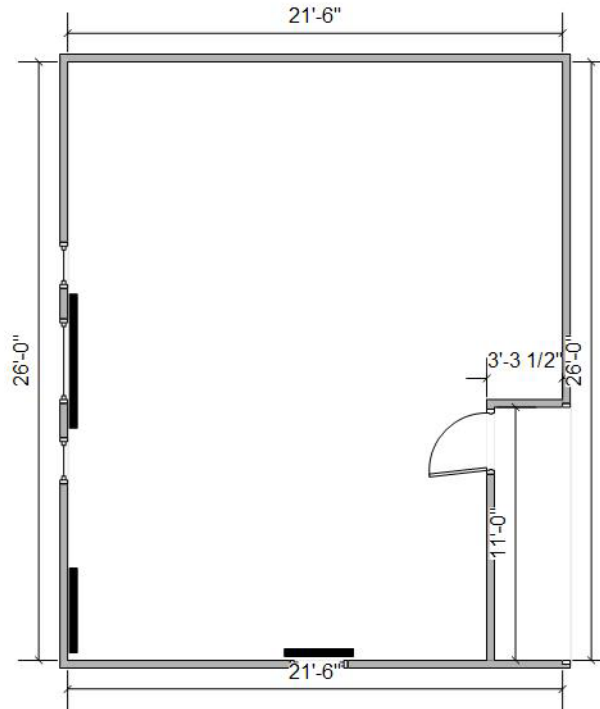

Auditorium	Classroom	Boardroom	Hollow Square Boardroom	U-Shape Boardroom	Double U-Shape Boardroom	Half Rounds	Rounds	Informal
50	20	16	16	12	-	18	24	30

# Carriage House

Hayloft

867 Sq. Ft.

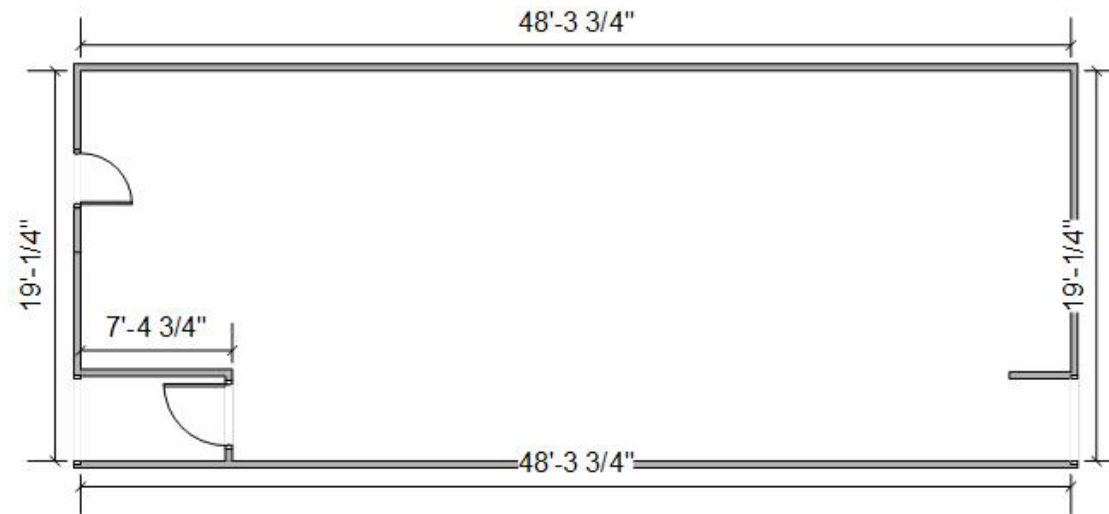

Auditorium	Classroom	Boardroom	Hollow Square Boardroom	U-Shape Boardroom	Double U-Shape Boardroom	Half Rounds	Rounds	Informal
85	48	32	32	28	-	30	40	60

# Carriage House

Tack Room

150 Sq. Ft.

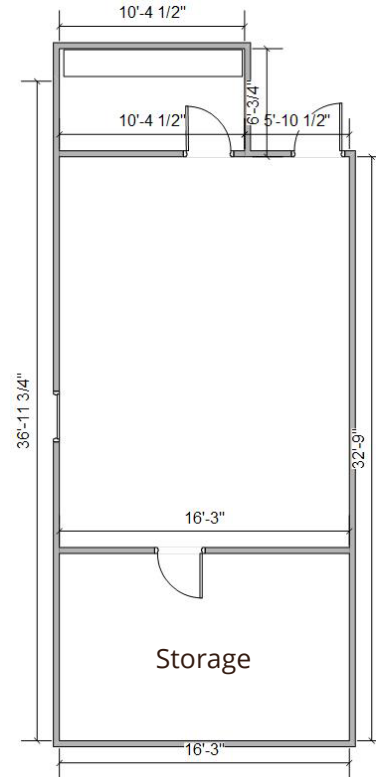

Auditorium	Classroom	Boardroom	Hollow Square Boardroom	U-Shape Boardroom	Double U-Shape Boardroom	Half Rounds	Rounds	Informal
20	12	16	-	-	-	12	16	20



# Cedar Ridge

## Lower & Upper Meeting Rooms

Lower Meeting Room  
558 Sq. Ft.

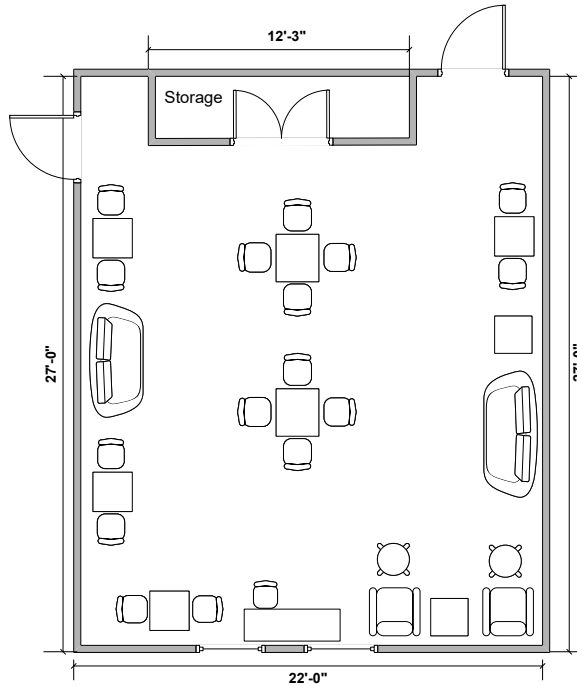

Upper Meeting Room  
558 Sq. Ft.

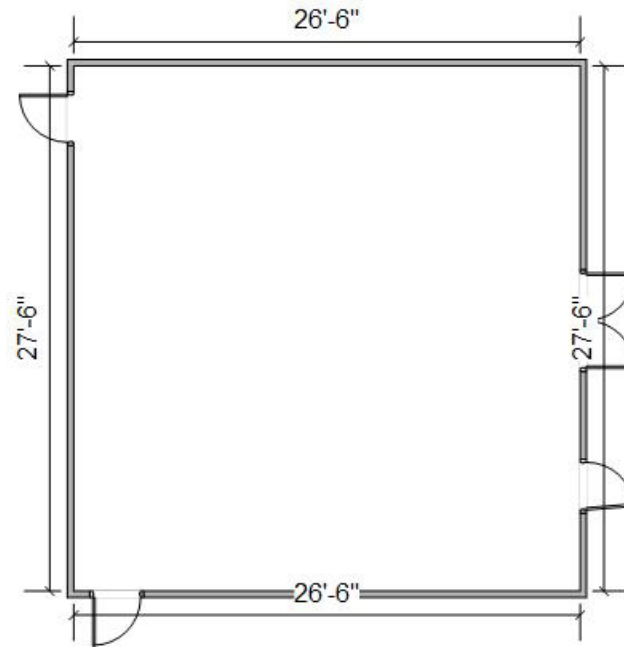

	Auditorium	Classroom	Boardroom	Hollow Square Boardroom	U-Shape Boardroom	Double U-Shape Boardroom	Half Rounds	Rounds	Informal
Lower Meeting Room	-	-	-	-	-	-	-	-	30
Upper Meeting Room	70	33	22	22	16	-	30	40	32

# Oaks

## Meeting Room

752 Sq. Ft.

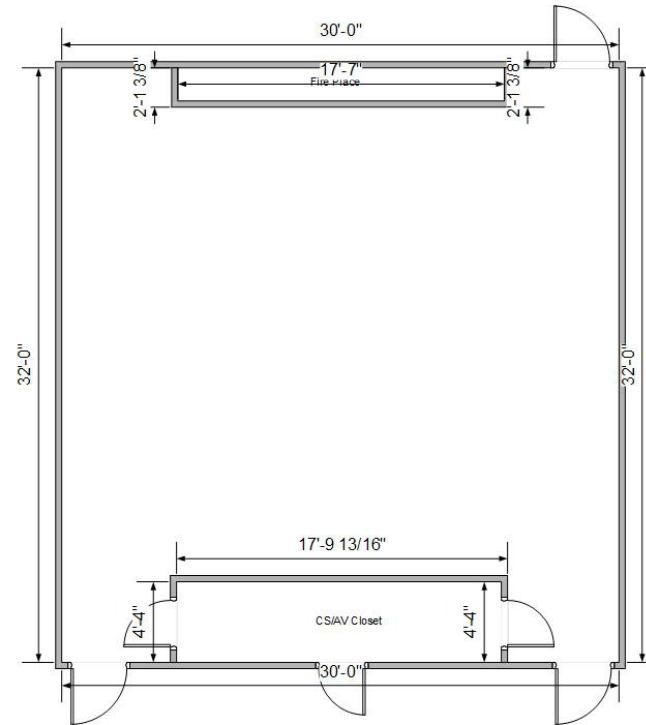

Auditorium	Classroom	Boardroom	Hollow Square Boardroom	U-Shape Boardroom	Double U-Shape Boardroom	Half Rounds	Rounds	Informal
60	36	22	36	24	-	30	40	40

# Glenview

Meeting Room

418 Sq. Ft.

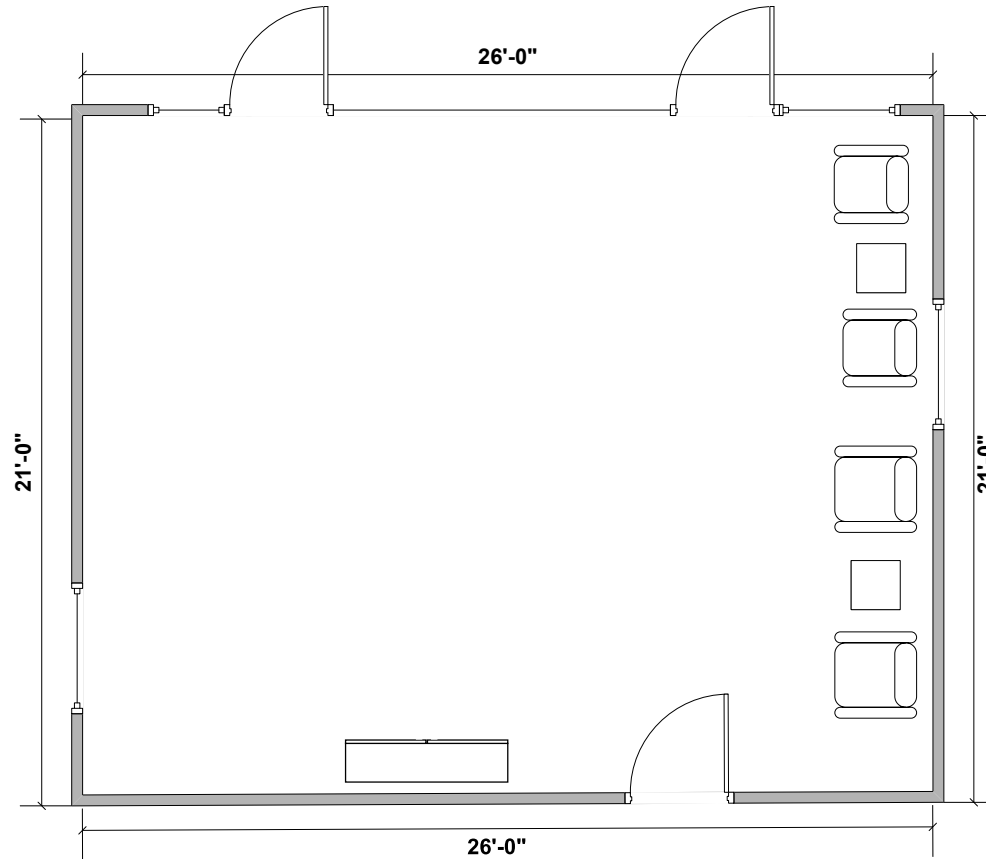

Auditorium	Classroom	Boardroom	Hollow Square Boardroom	U-Shape Boardroom	Double U-Shape Boardroom	Half Rounds	Rounds	Informal
48	24	22	24	16	-	25	30	36







# Meeting Room Configuration

Auditorium

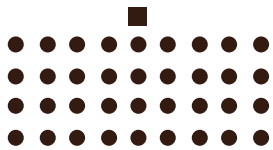

Classroom



Hollow Square

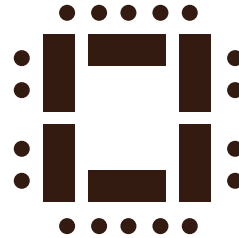

Half Rounds

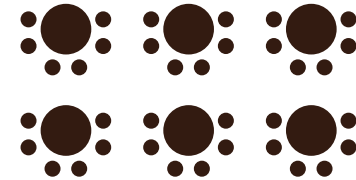

Informal



Rounds

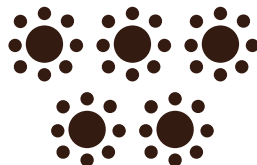

U-Shaped

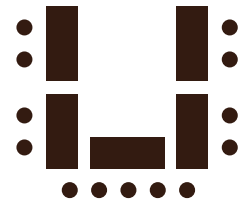

Boardroom

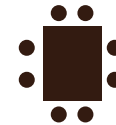

*Additional custom room set-ups are available. Speak with your Sales Manager or Event Planner who can provide options and room diagrams.*



## Meeting & Events



[gleneyrie.org](https://gleneyrie.org)



[sales@gleneyrie.org](mailto:sales@gleneyrie.org)



719-272-7700



3820 North 30th Street,  
Colorado Springs, CO 80904

